

VERDERFLEX[®]



Peristaltic Industrial Hose Pump

Spare Parts List

Dura
5, 7, 10, 15, 25, 35

Version 2.9v-06/2023

Print-No. 01

Original instructions (en)

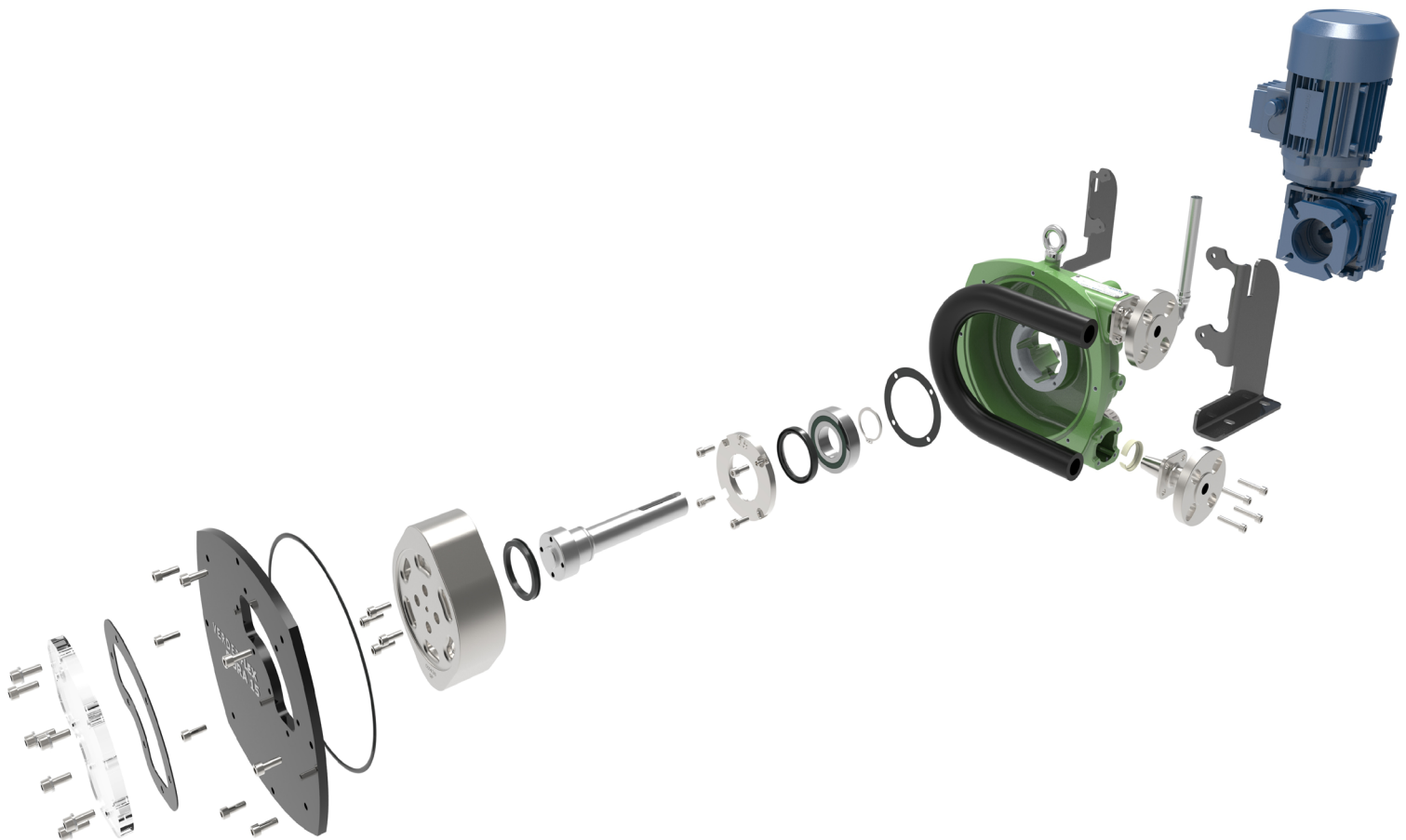

VERDER
passion for pumps



Version 2.9v-06/2023
Print-No. 01

Dura
5, 7, 10, 15, 25, 35

Dura MK IV 5, 7 and 10 Spare Parts List

This document contains a list of spares to help maintain and repair the Dura 05-35 peristaltic pumps. If in doubt, please contact your local Verder distributor and provide the pump serial number for genuine Verderflex® spares.

Pump Layout – Exploded view Dura MK IV 5, 7 and 10

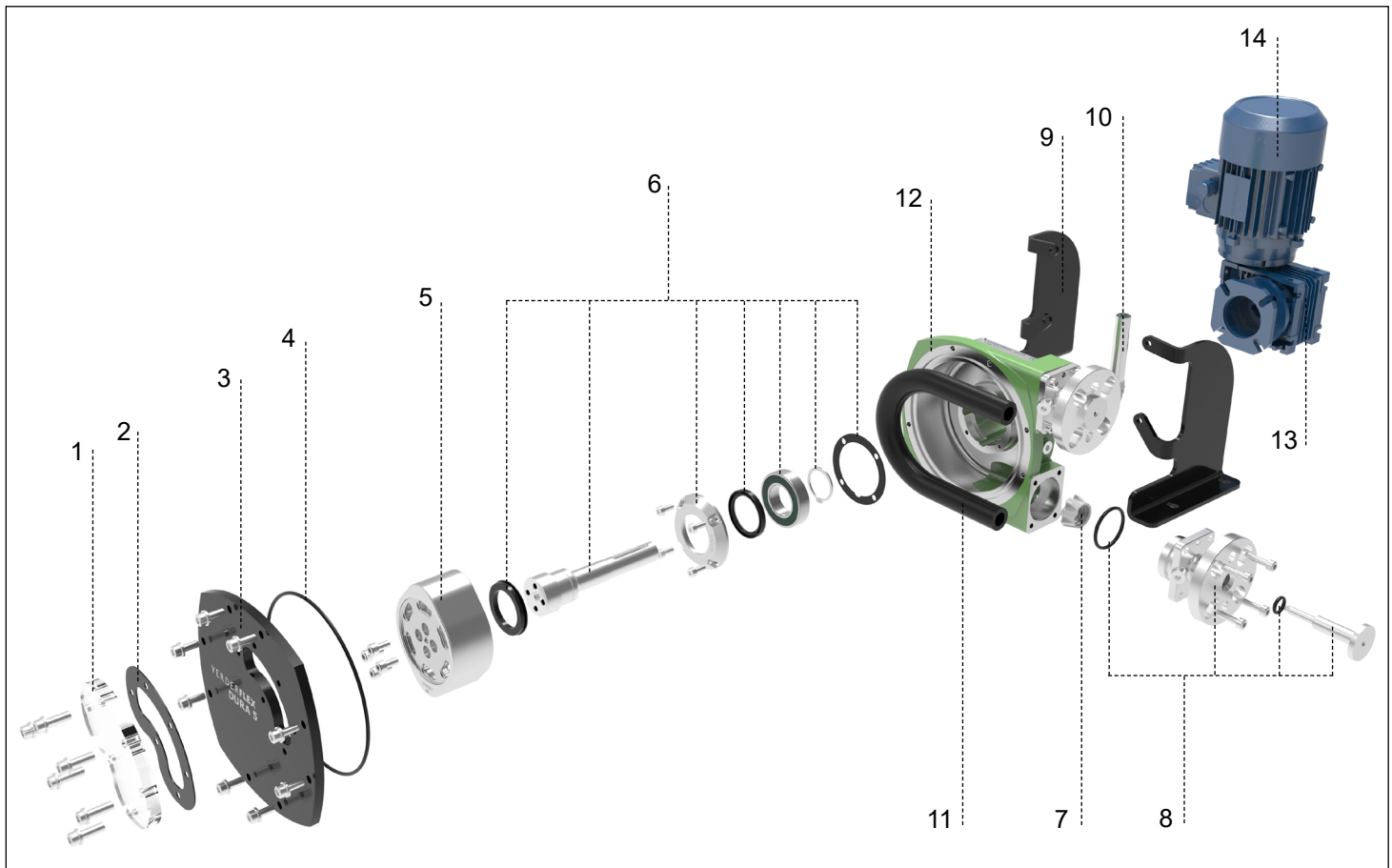

Figure 3 Dura MK IV 5, 7, 10 Exploded View (Generic View)

1	Inspection Window	6	Shaft Assembly	11	Hose
2	Inspection Window Gasket	7	Clamp Ring ¹⁾	12	Pump Housing
3	Front Cover	8	Port Flange ¹⁾	13	Gearbox with Adaptor Flange
4	O-Ring	9	Frames	14	Motor
5	Rotor	10	Filler Tube		



CAUTION

Ensure the spare parts (e.g hose, clamp ring and port flange) are installed as indicated in Dura 05-35 operating manual.

¹⁾ Applies to Dura MKIV 5, 7, 10 only. (→ refer to Dura 05-35 operating manual)

Dura MK III 15, 25 and 35 Spare Parts List

Table 1 contains a list of spares to help maintain and repair the Dura 05-35 peristaltic pumps. If in doubt, please contact your local Verder distributor with the pump serial number for genuine Verderflex® spares.

Pump Layout – Exploded view Dura MK III 15, 25 and 35

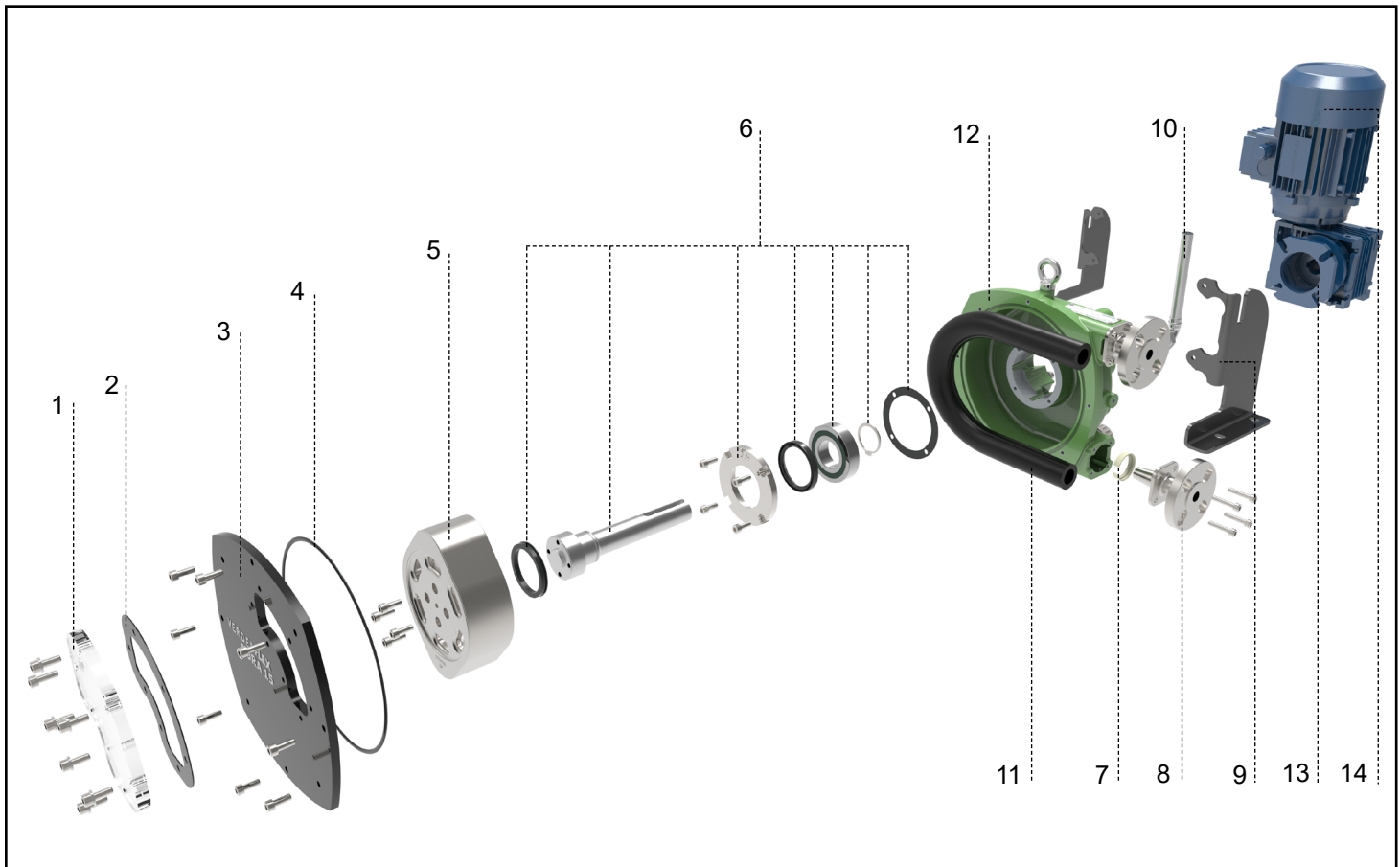

Figure 1 Layout - Dura MK III 15, 25, 35 Generic View

1	Inspection Window	6	Shaft Assembly	11	Hose
2	Inspection Window Gasket	7	Clamp Ring ¹⁾	12	Pump Housing ³⁾
3	Front Cover	8	Port Flange	13	Gearbox with Adaptor Flange
4	O-Ring	9	Frames	14	Motor
5	Rotor	10	Filler Tube ²⁾		



CAUTION

Ensure the spare parts (e.g hose, clamp ring and port flange) are installed as indicated in Dura 05-35 operating manual.

¹⁾ Applies to D15, D25, D35.

²⁾ For D25, D35 use polypropylene filler tube instead of copper filler tube.

³⁾ Dura MK III pumps can be identified by the use of 4 mounting bolts on the rear drive boss rather than the single bolt design of earlier versions.

Table 1 Dura MK 05-35 Spare Parts List











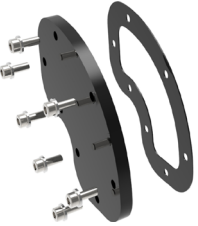

Ref	Item	Part No		Qty	Image
1.	Front Cover Inspection Window	D 5	139.2221.P	1	
		D 7	139.2221.P		
		D 10	139.2221.P		
		D 15	139.2222.P		
		D 25	139.2223.P		
		D 35	139.2224.P		
2.	Front Cover Inspection Window Gasket	D 5	139.2237	1	
		D 7	139.2237		
		D 10	139.2237		
		D 15	139.2235		
		D 25	139.2236		
		D 35	139.2233		
2.1	Front Cover Inspection Window and Gasket Assembly	D 5	139.2221.PA	1	
		D 7	139.2221.PA		
		D 10	139.2221.PA		
		D 15	139.2222.PA		
		D 25	139.2223.PA		
		D 35	139.2224.PA		
	Front Cover Inspection Window and Gasket Assembly for ATEX Rated Pumps	D 5	149.2227	1	
		D 7	149.2227		
		D 10	149.2227		
		D 15	149.2228		
		D 25	149.2229		
		D 35	149.2230		
3.	Front Cover	D 5	149.0178	1	
		D 7	149.0178		
		D 10	149.0178		
		D 15	139.0140.S		
		D 25	139.0141.S		
		D 35	139.0142		
3.1	Front Cover Assembly	D 5	149.0177	1	
		D 7	149.0177		
		D 10	149.0177		
		D 15	139.1140		
		D 25	139.1141		
		D 35	139.1142		

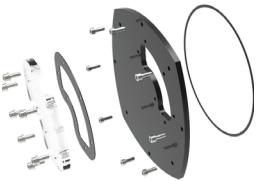
Table 1 Dura 05-35 Spare Parts List (continued)

Ref	Item	Part No	Qty	Image	
4.	Front Cover O-ring	D 5	139.0075	1	
		D 7	139.0075		
		D 10	139.0075		
		D 15	139.0076		
		D 25	139.0077		
		D 35	139.0078		
5.	Rotor Assembly	Standard Pressure Rotor		1	
		D 5	149.0105		
		D 7	149.0105		
		D 10	149.0106		
		D 15	149.0107		
		D 25	149.0108		
		D 35	149.0109		
		High Pressure Rotor			
		D 5	149.0110		
		D 7	149.0110		
		D 10	149.0111		
		D 15	149.0112		
D 25	149.0113				
D 35	149.0114				
6.	Shaft Assembly (complete with seals and bearings)	D 5	149.0115	1	
		D 7	149.0115		
		D 10	149.0115		
		D 15	149.0116		
		D 25	149.0117		
		D 35*	149.0118		
6.1	Shaft Seal Assembly	D 5	149.0119	1	
		D 7	149.0119		
		D 10	149.0119		
		D 15	149.0120		
		D 25	149.0121		
		D 35*	149.0122		
6.2	Bearing and Seal Assembly	D 5	149.0123	1	
		D 7	149.0123		
		D 10	149.0123		
		D 15	149.0124		
		D 25	149.0125		
		D 35*	149.0126		

* For D35 use O-ring instead of gasket.

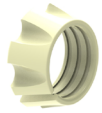
Table 1 Dura 05-35 Spare Parts List (continued)

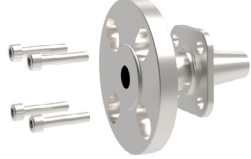
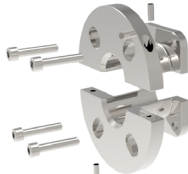
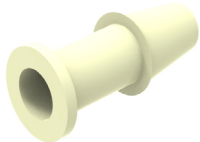
Ref	Item		Part No		Qty	Image		
7.	Clamp Ring (Supplied as Flange seal- ing kit)	Pair	D 5"	149.0185	-			
			D 7"					
			D 10**					
		Pair	D 15	139.2106				
		Pair	D 25	149.0225				
Pair	D 35	139.1045						
8.***	Standard Flange (supplied in pairs)	SS	D 5"	149.0179	1			
		SS	D 7"	149.0182				
		SS	D 10"	149.0226				
		SS	D 15	139.1335.A	1			
		PP****		obsolete				
		PVDF****		obsolete				
		SS	D 25	139.1336.A				
		PP****		obsolete				
		PVDF****		obsolete				
		SS	D 35	139.1337.A				
		PP****		Not available				
PVDF****	Not available							
8.1***	Split Flange (option)		D 10	obsolete			1	
			D 15	139.1335.B				
			D 25	139.1336.B				
			D 35	139.1337.B				
	Split Flange Insert (supplied in pairs)	PP	D 10	obsolete	1			
		PVDF		obsolete				
		PP	D 15	139.2132				
		PVDF		139.2133				
		PP	D 25	139.2142				
		PVDF		139.2143				
		PP	D 35	139.2182				
PVDF	139.2183							

** Applies to Dura MKIV 5, 7 and 10 only.

*** For temperature limits, please check the datasheet.

Table 1 Dura 05-35 Spare Parts List (continued)

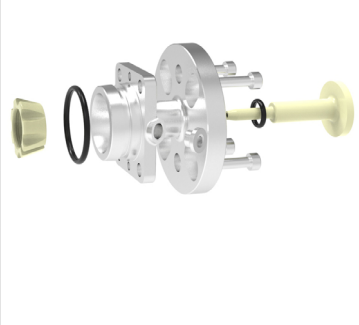
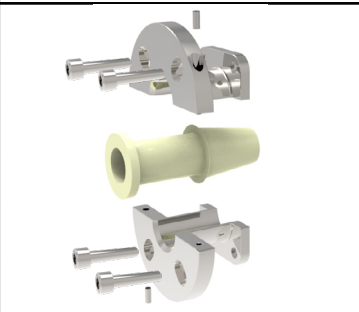
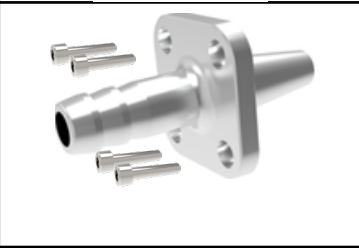
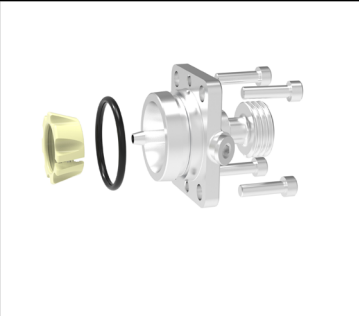
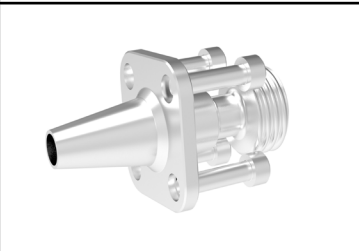
Ref	Item	Part No	Qty	Image	
8.2***	Split Flange Assembly with Insert (supplied in pairs)	PP	D 5**	149.0180	
		PVDF	D 5**	149.0181	
		PP	D 7**	149.0183	
		PVDF	D 7**	149.0184	
		PP	D 10**	149.0227	
		PVDF	D 10**	149.0228	
		PP	D 15	139.2238	
		PVDF	D 15	139.2240	
		PP	D 25	139.2232	
		PVDF	D 25	139.2243	
		PP	D 35	139.2281	
		PVDF	D 35	139.2283	
	Hose tail assembly C/W fasteners (supplied in pairs)	D 5	-	1	
		D 7	-		
D 10**		149.0229			
D 15		139.1335.H			
D 25		149.0224			
D 35		-			
8.3	Hygienic Flange DIN11851 (supplied in pairs)	D 5**	149.0205	1	
		D 7**	149.0206		
		D 10**	149.0231		
		D 15*****	149.0208	1	
			149.0209		
		D 25	149.0210		
		D 35*****	149.0211		
149.0212					

** Applies to Dura MKIV 5, 10 and 7 only.

*** For temperature limits, please check the datasheet.

***** Please note that D15 and D35 hygienic flanges are available in two sizes.

Table 1 Dura 05-35 Spare Parts List (continued)





Ref	Item		Part No		Qty	Image
8.4	Hygienic Flange Tri Clamp DIN32676-A <i>(supplied in pairs)</i>		D 5"	149.0215	1	
			D 7"	149.0216		
			D 10"	149.0230		
			D 15	149.0218		
			D 25	149.0219		
			D 35	149.0220		
9.	Frames STD Height		D 5	149.0101	1	
			D 7	149.0101		
			D 10	149.0101		
			D 15	149.0102		
			D 25	149.0103		
			D 35	149.0104		
9.1	Frames LOW Height		D 5	149.0132	1	
			D 7	149.0132		
			D 10	149.0132		
			D 15	149.0133		
			D 25	149.0134		
			D 35	149.0135		
10.	Filler Tube	Metal	D 5	149.0759.D	1	
			D 7	149.0759.D		
			D 10	149.0759.D		
		Polypropylene	D 15	149.0760		
			D 25	149.0762		
			D 35	149.0761		
N/A	Drain Plug Kit		D 5	149.7010	1	
			D 7	149.7010		
			D 10	149.7010		
			D 15	149.0129		
			D 25	149.0129		
			D 35	149.0131		

Table 2 Dura 05-35 Parts for reference (not supplied as individual spares by Verderflex)

Item	Description		Image
Mounting Frame Fasteners	D 5, 7, 10, 15	M6 x 12 - 8.8 Steel BZP	
	D 25	M8 x 12 - 8.8 Steel BZP	
	D 35	M10 x 16 - 12.9 Steel BZP	
Rotor Screws	D 5, 7, 10	M6 x 12 - 8.8 Steel BZP CS	
	D 15	M6 x 16 - 8.8 Steel BZP	
	D 25	M8 x 16 - 8.8 Steel BZP	
	D 35	M8 x 20 - 12.9 Steel BZP CS	
Front Cover Screws	D 5, 7, 10, 15	M6 x 16 - 8.8 Steel BZP	
	D 25	M8 x 16 - 8.8 Steel BZP	
	D 35	M8 x 20 - 8.8 Steel BZP	
Port Flange Screws	D 5, 7, 10, 15 (MK3)	M6 x 30 - 12.9 Steel BZP	
	D 5, 7, 10 (MK4)	M6 x 25 - 8.8 Steel BZP	
	D 25, 35	M8 x 45 - 12.9 Steel BZP	
Inspection Window Screws	D 5, 7, 10, 15	M6 x 20 - 12.9 Steel BZP	
	D 25	M6 x 20 - 12.9 Steel BZP	
	D 35	M6 x 20 - 12.9 Steel BZP	

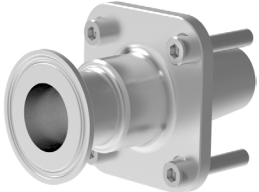
Table 3 Dura 05-35 Accessories

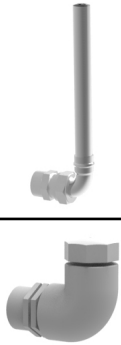

Item	Part No		Image
Revolution sensor	D 5, 7, 10, 15, 25, 35	129.0805	
Hose burst and vent kit	D 5, 7, 10, 15	149.0719	
	D 25	149.0722	
	D 35	149.0723	
Hose burst and vent kit for ATEX rated pumps	D 5, 7,10 (Pos1)	149.0724	 <div style="display: flex; justify-content: space-around; width: 100%;"> Pos1 Pos2 </div>
	D 5, 7,10 (Pos2)	149.0725	
	D 15 (Pos1)	149.0726	 <div style="display: flex; justify-content: space-around; width: 100%;"> Pos1 Pos2 </div>
	D 15 (Pos2)	149.0727	

Table 3 Dura 05-35 Accessories (continued)



Item	Part No		Image
Hose burst and vent kit for ATEX rated pumps	D 25	149.0728	
	D 35	149.0729	
Hose burst and vent kit for plastic filler tube	D 5	149.0859.HB	
	D 7	149.0859.HB	
	D 10	149.0859.HB	
	D 15	149.0860.HB	
	D 25	149.0860.HB	
	D 35	149.0861.HB	
High Level Sensor Assembly	D 25	149.0721	
	D 35	149.0720	

Table 4 Dura 05-35 Hose Options

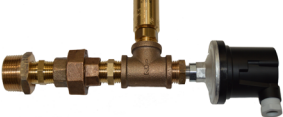
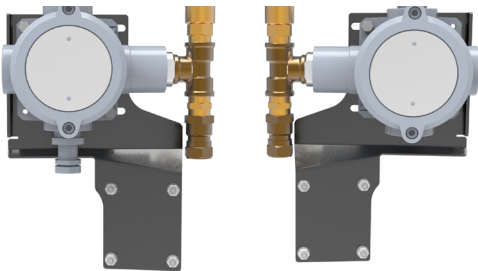
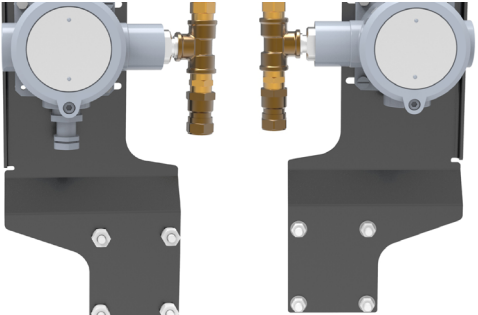



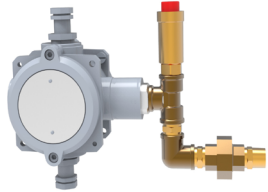
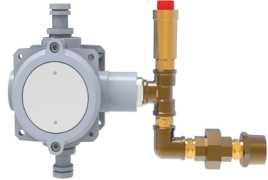
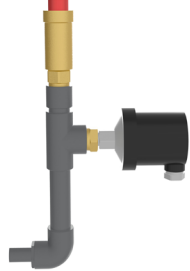
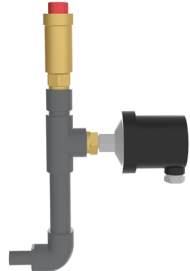

Item		Part No		Qty	Image
Hose option <i>NR/White</i>	singles	D 5	139.2080	1	
		D 7	139.2085		
		D 10	139.0001		
		D 15	139.0002		
		D 25	139.0003		
		D 35	139.0004		
Hose option <i>NBR/Yellow</i>	singles	D 5	139.2082	1	
		D 7	139.2087		
		D 10	139.0512		
		D 15	139.0513		
		D 25	139.0514		
		D 35	139.0515		
Hose option <i>NBRF/Yellow + White</i>	singles	D 5	-	1	
		D 7	-		
		D10	139.2021		
		D15	139.2022		
		D25	139.2023		
		D35	139.2024		
Hose option <i>Hypalon® / Green</i>	singles	D 5	139.2081	1	
		D 7	139.2086		
		D 10	139.2010		
		D 15	139.2011		
		D 25	139.2012		
		D 35	139.2013		
Hose option <i>EPDM/Red</i>	singles	D 5	-	1	
		D 7	-		
		D 10	139.0010		
		D 15	139.0011		
		D 25	139.0012		
		D 35	139.0013		
Hose option <i>Verderprene option/White</i>	singles	D 5	139.2030	1	
		D 7	-		
		D 10	139.2031		
		D 15	139.2032		
		D 25	139.2033		
		D 35	139.2034		

Table 5 Dura 05-35 Pump Lubricants

The pump must always be filled with the correct amount of lubricant to the middle level marks of the front cover. Table 5 shows the standard amount of lubricant supplied with Dura pumps in litres and US gallons.

Pump Size	Lubricant	Standard Quantity Supplied with Pump in Litre (US Gallons)	Part No
Dura 05	Verderlube® VerderSil®	0.5 (0.1)	129.1418 129.1372
Dura 07	Verderlube® VerderSil®	0.5 (0.1)	129.1418 129.1372
Dura 10	Verderlube® VerderSil®	0.5 (0.1)	129.1418 129.1372
Dura 15	Verderlube® VerderSil®	0.5 (0.1)	129.1418 129.1372
Dura 25	Verderlube® VerderSil®	2.0 (0.5)	129.1419 (Qty. 1Lx2) 129.1373 (Qty. 1Lx2)
Dura 35	Verderlube® VerderSil®	2.5 (0.7)	129.2379 129.2505

Trademarks

VERDERFLEX® is a registered trademark of Verder Liquids B.V. No permission is granted to use any Verder, trademarks or trade names included in this document without the prior written agreement of Verder Liquids B.V.

Tri-clamp® is a registered trademark of Alfa Laval Corporate AB.

Hypalon® is a registered trademark of RSCC Wire & Cable LLC.

Document history

Version	Description	Date	Approved
2.8	Addition of MK4 screws	16/3/23	ISH
2.9	Clamp ring seals changed to 'pair'	20/6/23	AJB